

FMM FOR HIGHLY OSCILLATORY
PROBLEMS

PROF. VLADIMIR ROKHLIN

YALE

Subject of This Talk

- FMMs for the Helmholtz (Maxwell's) Equation at High Frequency
- Overview, state of implementation, etc.
- Something of a misnomer and a misconception
- Disclaimer: Boeing, HRL, Illinois, MadMax...
- Expected audience

FMM for the Helmholtz (Maxwell) Equation

- Function: evaluate potentials, fields, etc. of charge distributions. N^2 vs. N or $N \cdot \log(N)$, or $N \cdot (\log(N))^2$. . .
- Does not provide discretizations, integral formulations, iterative solvers, etc. (left to the user as an exercise)
- Indifferent to all of these issues - explain
- In reality, consists of two procedures. One is used on the subwavelength scale (or in low-frequency environments), the other is used in the high-frequency environment; transition is seamless

Low-Frequency (Subwavelength) Environment

- Similar to Laplace - explain
- Very simple “bare-bones” scheme, more involved “modern” versions
- Fairly fast: (several times slower than the Laplace FMM) for groups up to 4λ or so (define the groups)
- Break-even points
- Behavior as groups increase
- Serious deterioration for groups greater than 5 to 8λ
- Fairly simple implementations produce acceptable results

High-Frequency Environment

- Not at all similar to the Laplace case: “oscillatory behavior”
- Example with the Moon
- “At a fixed number of points per λ , the rank of each submatrix is proportional to its size” - not quite true, Michielssen counterexample
- How bad is it?
- Let us see

At the Bottom of the Scheme

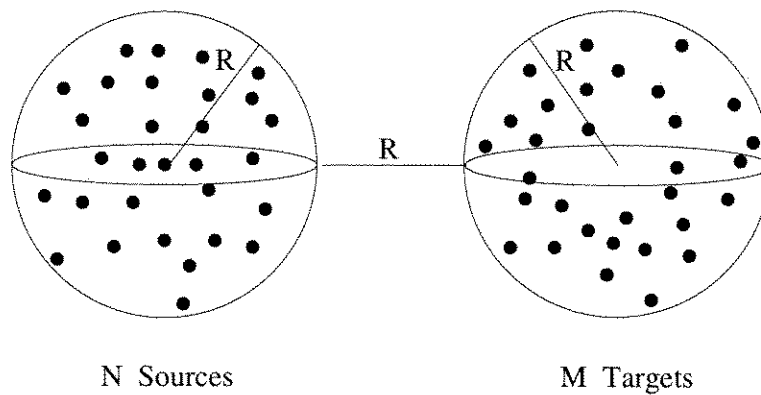

$$V(Q_i) = \sum_{j=1}^N q_j \frac{e^{ik\|Q_i - P_j\|}}{\|Q_i - P_j\|}$$

Direct evaluation requires $O(NM)$ work.

At the Bottom of the Scheme II

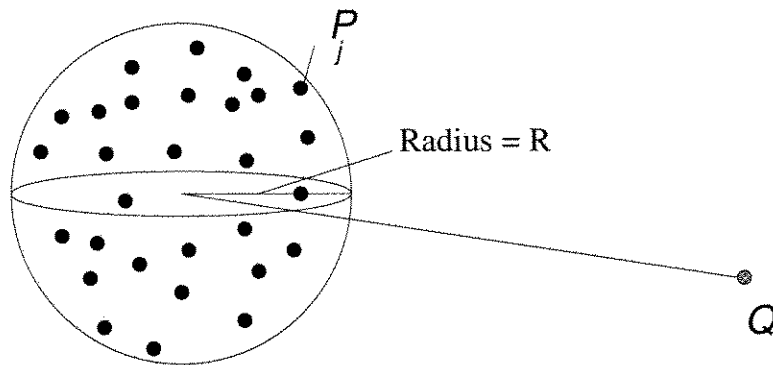

$$V(Q) = V(r, \theta, \phi) \approx \sum_{n=0}^p \sum_{m=-n}^n M_n^m Y_n^m(\theta, \phi) h_n(kr),$$

with multipole moments

$$M_n^m = \sum_{j=1}^N q_j Y_n^{-m}(\theta_j, \phi_j) j_n(kr), \quad P_j = (r_j, \theta_j, \phi_j)$$

In the low frequency regime, the error in the multipole approximation decays like $(R/|Q|)^{p+1}$.

For our simple example, $R/|Q| < 1/2$, so that setting $p = \log_2(\frac{1}{\varepsilon})$ yields a precision of ε .

At the Bottom III

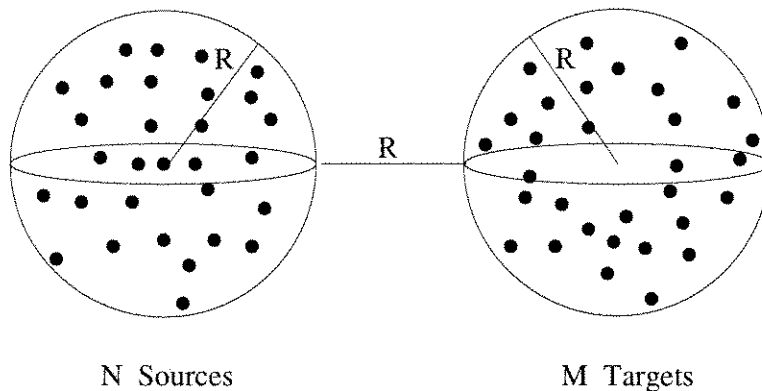

- Evaluate multipole coefficients M_n^m for $n = 0, \dots, p$
- Evaluate expansion at target points Q_j , for $j = 1, \dots, M$
- Total operation count: $p^2 \cdot (N + M) = (N + M) \cdot \log^2\left(\frac{1}{\epsilon}\right)$
- The schemes depend critically on p^2 being much smaller than N

Hard Life at High Frequencies

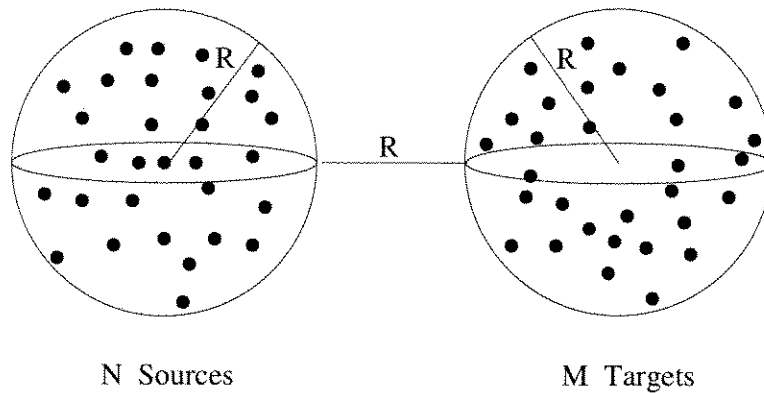

$$V(r, \theta, \phi) \approx \sum_{n=0}^p \sum_{m=-n}^n M_n^m Y_n^m(\theta, \phi) h_n(kr)$$

- Coefficients M_n^m do not start decaying until $n > |k \cdot R|$, after which decay is extremely rapid
- Condition $p > |k \cdot R| + O(|k \cdot R|^{1/3})$ is needed if we are to have any accuracy at all

Hard Life II

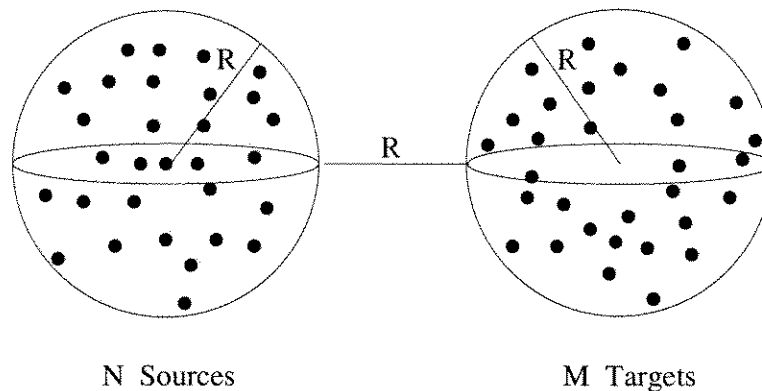

- p is proportional to $\frac{R}{\lambda}$
- In BIE discretizations: fixed number of nodes per λ^2
- Thus, total number of elements in the expansion is of the same order as N
- None of the $O(N \cdot \log(N))$ schemes (Barnes-Hut, etc.) will work in this regime

Hard Life III

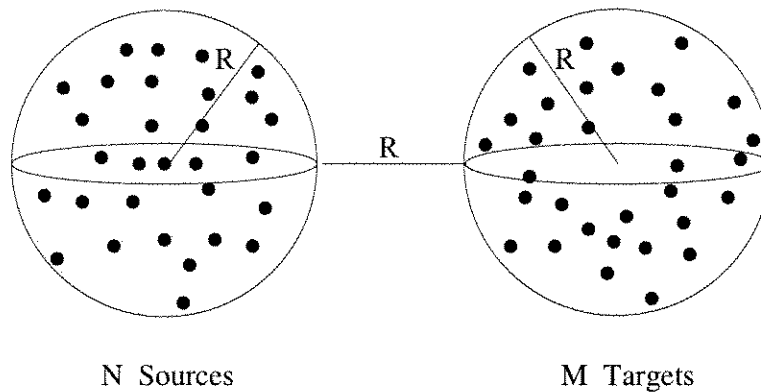

- Another way to put it: the rank approach will not work because the ranks are high
- Cooked goose, vicious gloating
- The situation is a little better when volume distributions and volume integrals are considered, but not enough - and there is FFT-based competition
- What about order N algorithms (FMMS)?

Translation Operators ($h \rightarrow h$)

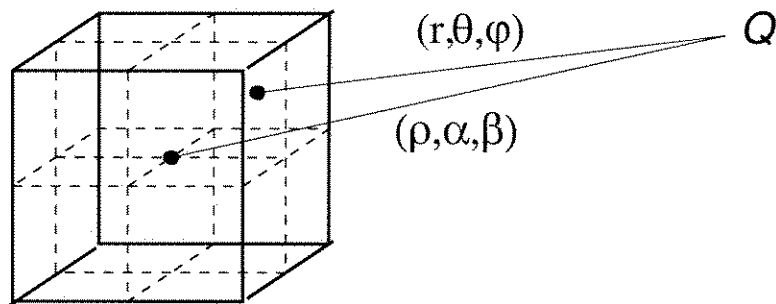

$$\begin{aligned} & \sum_{n=0}^p \sum_{m=-n}^n M_n^m Y_n^m(\theta, \phi) h_n(kr) \rightarrow \\ \rightarrow & \sum_{n=0}^p \sum_{m=-n}^n N_n^m Y_n^m(\alpha, \beta) h_n(k\rho) \end{aligned}$$

- Cost: $O(p^4)$
- $O(p^3)$ via “point and shoot” procedure
- Fatal in the BIE environment

Translation Operators ($h \rightarrow j$)

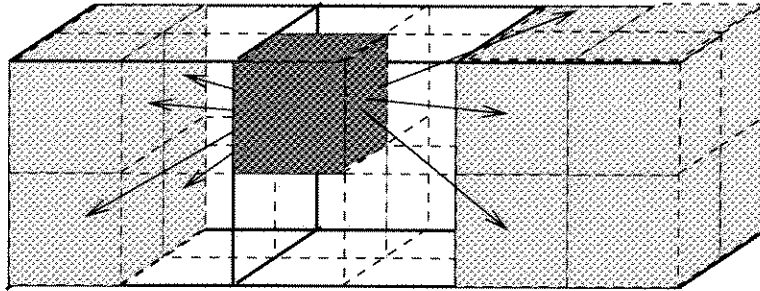

$$\sum_{n=0}^p \sum_{m=-n}^n M_n^m Y_n^m(\theta, \phi) h_n(kr) \rightarrow$$
$$\rightarrow \sum_{n=0}^p \sum_{m=-n}^n L_n^m Y_n^m(\alpha, \beta) j_n(k\rho)$$

- No better than $h \rightarrow h$
- Dominant type of translation in an FMM

Translation Operators ($j \rightarrow j$)

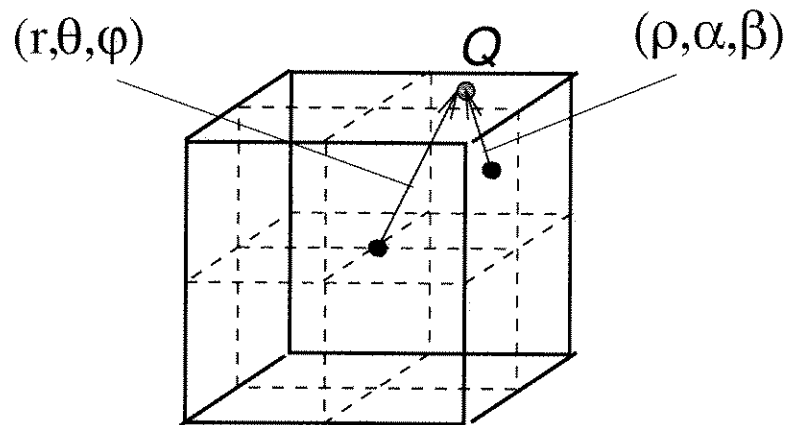

$$\begin{aligned} & \sum_{n=0}^p \sum_{m=-n}^n L_n^m Y_n^m(\theta, \phi) j_n(kr) \rightarrow \\ \rightarrow & \sum_{n=0}^p \sum_{m=-n}^n O_n^m Y_n^m(\alpha, \beta) j_n(k\rho) \end{aligned}$$

- Same as $h \rightarrow h$

Grim Observation

- Ranks of translation operators in the high-frequency Helmholtz (Maxwell's, etc.) environment are proportional to the sizes of the groups in wavelengths (with subtle exceptions - Michielssen)
- For surface distributions of charges, any FMM that as much as creates translation operators will be of order at least $O(N^2)$ - horror!
- Translation operators in their "point and shoot" form reduce best possible order to $O(N^{3/2})$ - not nearly good enough
- Classical translation operators are of little use in the construction of Helmholtz FMMs, except at low frequencies

What Is Needed

- Bases in which translation operators are diagonal, or at least very sparse
- Transitions between such bases must be very sparse
- Transitions between the standard representations (partial wave expansions) and the new bases must be very sparse
- Alternatively, it should be possible to carry out the whole procedure in the “dual” bases
- Where does one find such paragons?

A Pleasant Observation

- All translation operators on a given level are diagonalized by the same unitary operator
- All diagonal forms are available analytically
- Transitions between bases (corresponding to different levels) can be done in a “fast” manner
- The whole procedure is quite simple, as long as it is understood in an appropriate weak sense

Radiation Potentials and T_{hh}

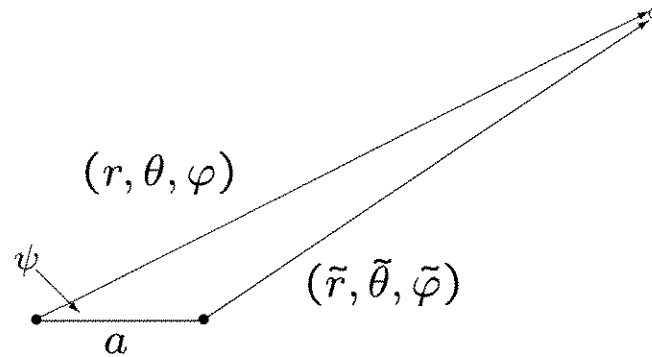

$$P(r, \theta, \varphi) = \sum_{n=-\infty}^{+\infty} \sum_{m=-n}^n M_n^m Y_n^m(\theta, \phi) h_n(kr)$$

$$P(\tilde{r}, \tilde{\theta}, \tilde{\varphi}) = \sum_{n=-\infty}^{\infty} \sum_{m=-n}^n \tilde{M}_n^m Y_n^m(\tilde{\theta}, \tilde{\phi}) h_n(k\tilde{r})$$

Sommerfeld condition:

$$\lim_{r \rightarrow \infty} P(r, \theta, \varphi) \cdot r \cdot e^{-i \cdot k \cdot r} = F(\theta, \phi)$$

Observation

The mapping

$$U : \{M_n^m\} \rightarrow F(\theta, \phi)$$

diagonalizes the translation operator

$$T_{hh} : \{M_n^m\} \rightarrow \{\tilde{M}_n^m\}$$

On the diagonal

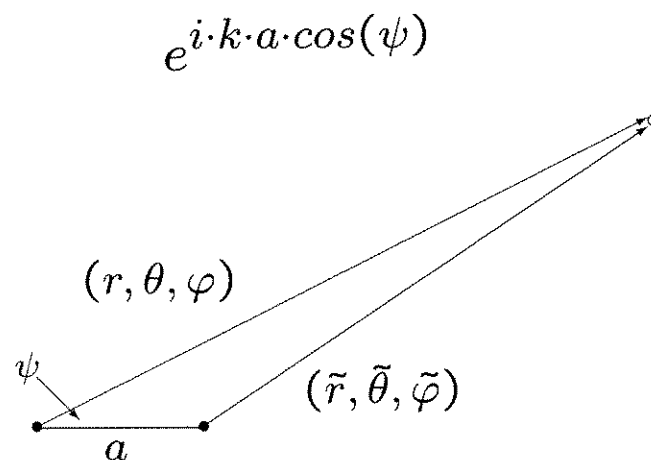

Proof:

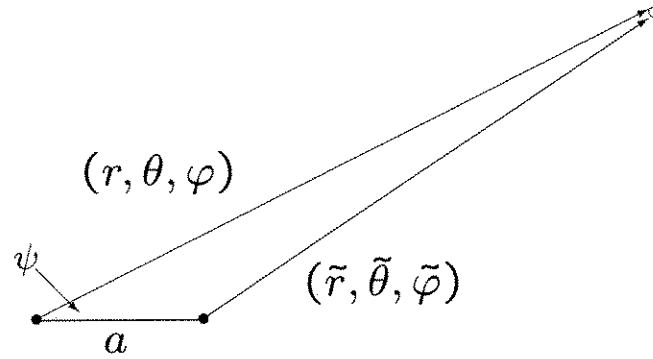

For large r ,

$$(\tilde{\theta}, \tilde{\varphi}) \sim (\theta, \varphi),$$

which means that the mapping

$$U^{-1} \circ T_{hh} \circ U : F \rightarrow \tilde{F}$$

is diagonal. For large r ,

$$\tilde{r} - r \sim a \cdot \cos(\psi),$$

and

$$(U^{-1} \circ T_{hh} \circ U) (\theta, \varphi) = e^{i \cdot k \cdot a \cdot \cos(\psi)}$$

What *Is* U?

For large r

$$h_m(kr) \sim \frac{e^{i \cdot k \cdot r}}{k \cdot r}$$

(up to some powers of i), and

$$\begin{aligned} & \sum_{n=0}^p \sum_{m=-n}^n M_n^m Y_n^m(\theta, \varphi) h_n(kr) \sim \\ & \sim \frac{e^{i \cdot k \cdot r}}{k \cdot r} \sum_{n=0}^p \sum_{m=-n}^n M_n^m Y_n^m(\theta, \varphi) = F(\theta, \varphi) \end{aligned}$$

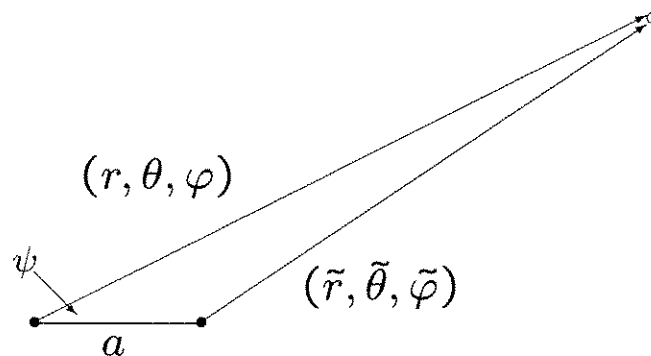

What Have We Achieved?

- T_{hh} is a spherical convolution; it is diagonalized by the spherical harmonic transform; its diagonal form is a function living on S^2 .
- T_{hh} is unitary; its diagonal is $e^{i \cdot k \cdot a \cdot \cos(\psi)}$
- Direct result of the Sommerfeld condition, and has been known for a long time
- And what about T_{jj} and T_{hj} ?

Diagonalizing T_{jj}

For large r

$$j_m(kr) \sim \frac{\cos(k \cdot r)}{k \cdot r}$$

(up to some phase corrections), and

$$\begin{aligned} & \sum_{n=0}^p \sum_{m=-n}^n M_n^m Y_n^m(\theta, \varphi) j_n(kr) \sim \\ & \sim \frac{\cos(k \cdot r)}{k \cdot r} \sum_{n=0}^p \sum_{m=-n}^n M_n^m Y_n^m(\theta, \varphi) = F(\theta, \varphi) \end{aligned}$$

- A Sommerfeld condition of sorts

Diagonalizing T_{jj} II

$$\sum_{n=0}^p \sum_{m=-n}^n M_n^m Y_n^m(\theta, \varphi) j_n(kr) \sim$$
$$\sim \frac{\cos(k \cdot r)}{k \cdot r} \sum_{n=0}^p \sum_{m=-n}^n M_n^m Y_n^m(\theta, \varphi)$$

- Makes no physical sense whatsoever
- As $p \rightarrow \infty$, the limit usually does not even exist!
- First truncate, then take the limit; for this, we will pay later
- Diagonalized by the harmonic transform, same as T_{hh} ; the same $e^{i \cdot k \cdot a \cdot \cos(\psi)}$ on the diagonal
- Purely formal expedient

Corollary

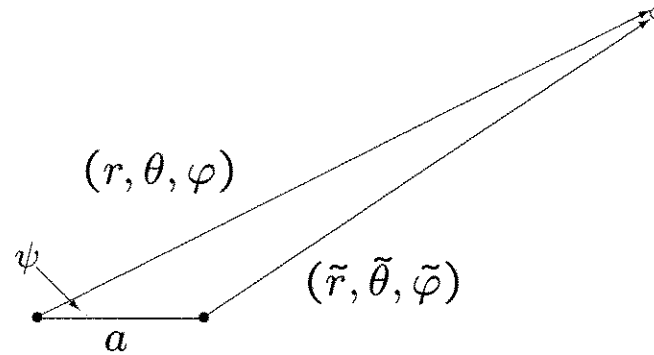

Far-field signature of a unit charge is given by the formula

$$F(\theta, \varphi) = e^{i \cdot k \cdot a \cdot \cos(\psi)};$$

The potential at the point (a, θ, φ) of the J – *expansion* with the far-field signature σ is given by the formula

$$P(a, \theta, \varphi) = \int_{S^2} \sigma(\tilde{\theta}, \tilde{\varphi}) \cdot e^{-i \cdot k \cdot a \cdot \cos(\psi)} ds$$

What about T_{hj} ?

- We will use the Category Theory!

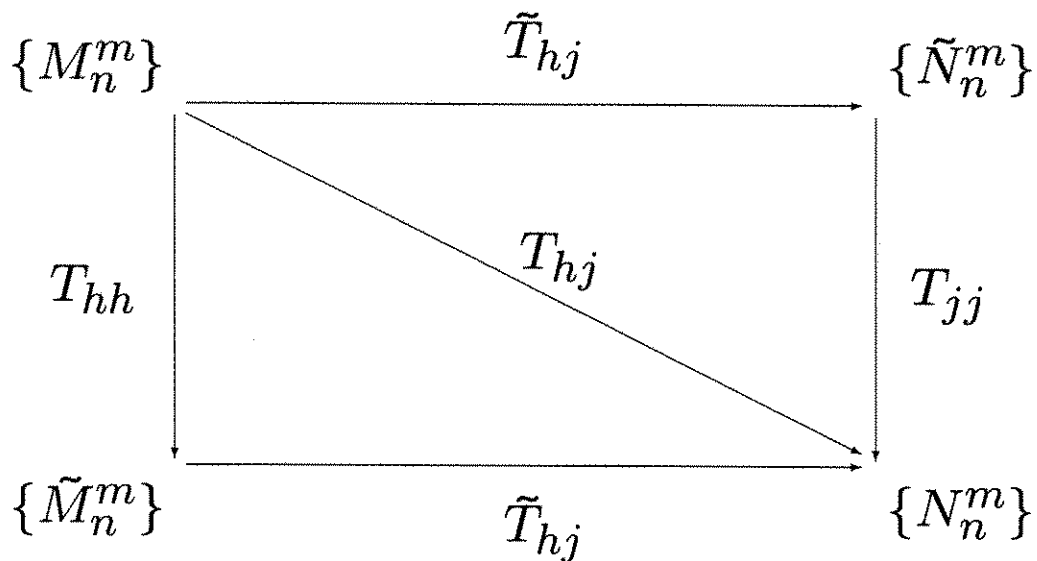

- Operators T_{hh} , T_{jj} are diagonal in the far-field representation, and $T_{hh} = T_{jj}$
- Furthermore,

$$T_{jj} \circ \tilde{T}_{hj} = \tilde{T}_{hj} \circ T_{hh}$$

- Inevitable consequences
- Commutative diagrams, morality, etc.

What Is On The Diagonal?

$$\sum_{n=0}^{\infty} (2n + 1) h_n(k\rho) P_n(\cos(\psi))$$

- “Addition theorem”
- Abramovitz and Stegun
- Series above is divergent; truncation, accuracy, dynamic range, etc.
- Usual situation with convolutions with divergent sequences
- Analysis is a little detailed; results are summarized below
- Variations: beam-like translation operators, etc.

Summary

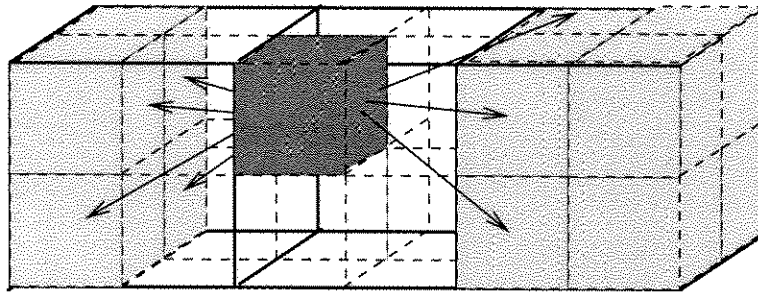

- All translations within one level are diagonalized by the far-field signature
- Far-field signatures of charge (dipole, whatever) distributions are given by simple formulae, and fairly inexpensive to evaluate
- Far-field signatures are smooth functions on the sphere, and can be represented by tables of their values - elaborate
- Transitions between levels involve interpolation and filtering of functions on the sphere. Interpolation is easy; filtering has been taken care of (Alpert-Jacob-Chien Algorithm, Dembart and VR, etc.)

“Low-Frequency Break-Down”

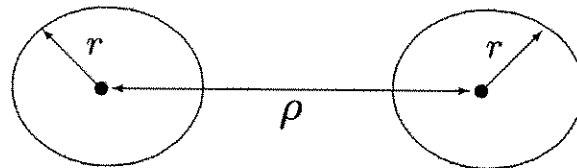

- Outgoing h -expansion behaves as $j_n(k r)$
- Incoming j -expansion is a convolution of the outgoing h -expansion with the original (physical space) translation operator; the latter behaves as $h_n(k \rho)$
- The potential at a point within the target sphere (circle) is obtained as an inner product of the incoming j -expansion with a sequence behaving as $j_n(k r)$

“Low-Frequency Break-Down”

II

Behavior of Bessel Functions:

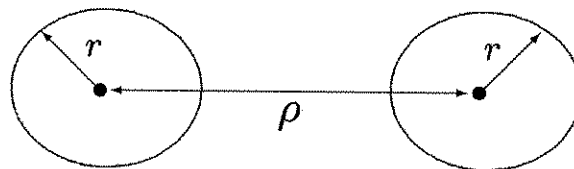
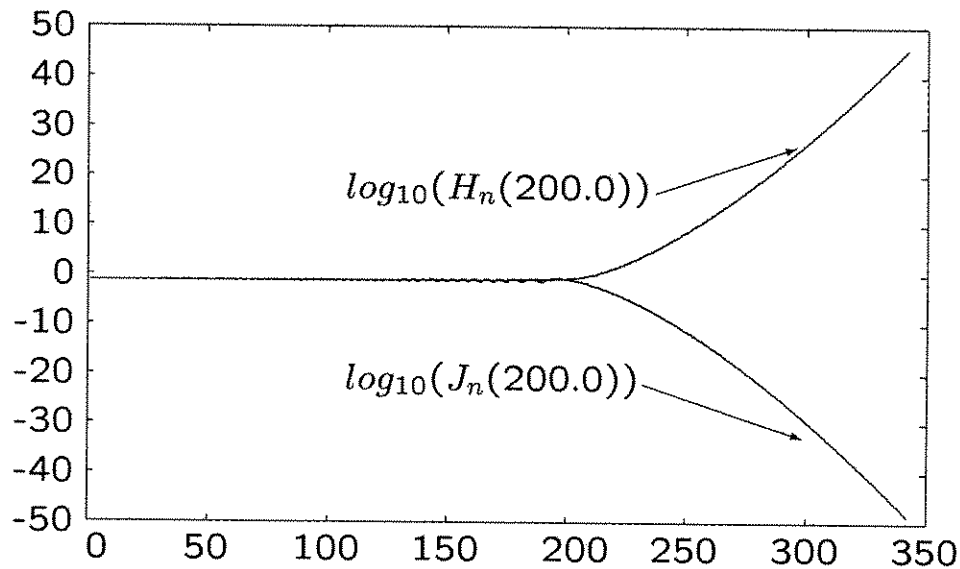

- When convolutions are done explicitly, the procedure is numerically stable as long as the spheres do not intersect (physics never lies, even if it takes a conspiracy)

“Low-Frequency Break-Down”

III

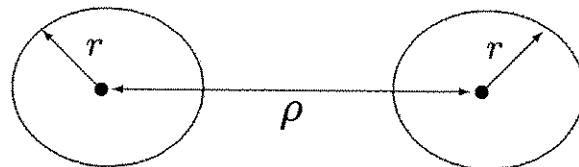

- When convolutions are done via Fourier Transforms (or via spherical transforms) the *dynamic range* of each sequence must not be large. In other words, $J_n(kr)$ must **implode** before $H_{2n}(k\rho)$ **explodes**
- For sufficiently large kr , the condition $\rho \geq 3r$ is sufficient. For smaller r , greater separation is needed
- Separation depends on the required accuracy, kr , and the machine ε - explain
- In this case, a table is worth a thousand theories

“Low-Frequency Break-Down” : Table

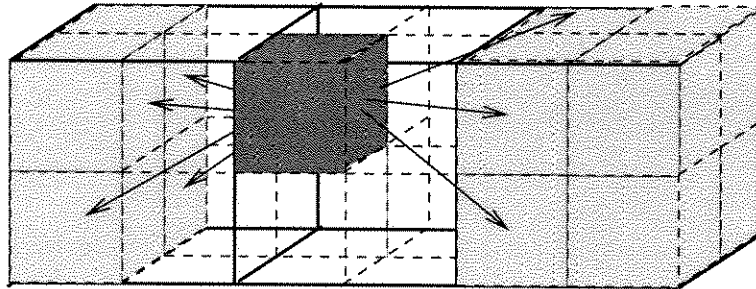

- Double precision calculations

3 digits 0.25λ side of the cube

6 digits 3.50λ side of the cube

9 digits 12.0λ side of the cube

- Similarity with evaluation $\sin(10)$
 - explain
- Marginal improvements are possible

“Low-Frequency Break-Down” : Remedy

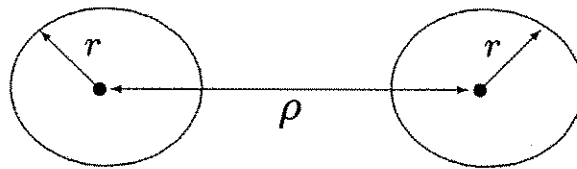

- What does one do in the subwavelength regime?
- Use the low-frequency version of the FMM
- Transition to the high-frequency (diagonal) version at the appropriate point
- We have not tried to play with the size of the buffer

Numerical Examples

q

A-10

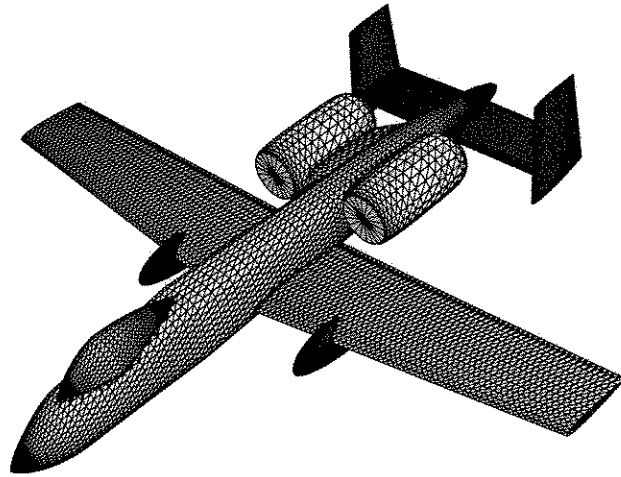

- 50 wavelengths in size
- Smallest triangle: $1.06\text{E-}6 \lambda$
- Largest triangle: $2.86\text{E-}1 \lambda$
- Number of triangles: 706,300
- Single node per triangle

A-10 - Helmholtz

T (dir.)	Acc.	Error (pot.)	Error (grad.)	T (sec.)	Mem. (Mb)
337329	10^{-3}	0.43E-3	0.56E-3	485	300
337329	10^{-6}	0.48E-6	0.50E-6	1291	790
337329	10^{-9}	0.11E-9	0.95E-10	2947	1143

A-10 - Laplace

T (dir.)	Acc.	Error (pot.)	Error (grad.)	T (sec.)	Mem. (Mb)
60590	10^{-3}	0.27E-3	0.37E-4	48.3	211
60590	10^{-6}	0.19E-6	0.43E-7	119	292
60590	10^{-9}	0.85E-10	0.61E-11	2437	376

Horse

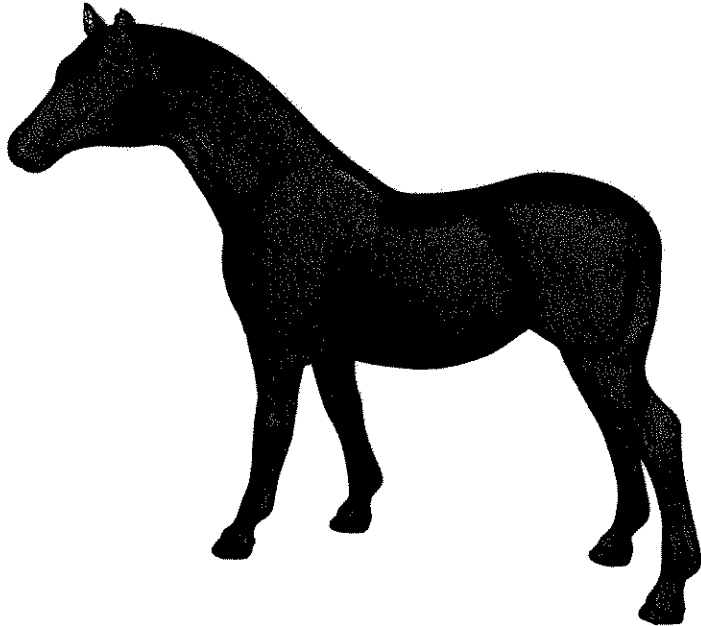

- 50 wavelengths in size
- Smallest triangle: $9.34\text{E-}3 \lambda$
- Largest triangle: $3.27\text{E-}1 \lambda$
- Number of triangles: 872,694
- Single node per triangle

Horse - Helmholtz

T (dir.)	Acc.	Error (pot.)	Error (grad.)	T (sec.)	Mem. (Mb)
646143	10^{-3}	0.65E-3	0.31E-3	672	549
646143	10^{-6}	0.66E-6	0.92E-7	1832	1111
646143	10^{-9}	0.33E-9	0.33E-11	3515	2027

Horse - Laplace

T (dir.)	Acc.	Error (pot.)	Error (grad.)	T (sec.)	Mem. (Mb)
107833	10^{-3}	0.91E-3	0.57E-3	63.7	328
107833	10^{-6}	0.46E-6	0.31E-6	139.7	322
107833	10^{-9}	0.25E-9	0.10E-9	298	584

Sphere

- 50 wavelengths in size
- Smallest triangle: $4.91E-2 \lambda$
- Largest triangle: $6.27E-2 \lambda$
- Number of triangles: 619,520
- Single node per triangle

Sphere - Helmholtz

T (dir.)	Acc.	Error (pot.)	Error (grad.)	T (sec.)	Mem. (Mb)
324381	10^{-3}	0.27E-3	0.19E-3	521	416
324381	10^{-6}	0.15E-6	0.42E-7	1358	914
324381	10^{-9}	0.91E-10	0.24E-10	2873	1474

Sphere - Laplace

T (dir.)	Acc.	Error (pot.)	Error (grad.)	T (sec.)	Mem. (Mb)
52936	10^{-3}	0.79E-3	0.90E-3	45	245
52936	10^{-6}	0.33E-6	0.45E-6	97.7	244
52936	10^{-9}	0.19E-9	0.12E-9	223	402

Cube

- 50 wavelengths in size
- Smallest triangle: $9.12E-2 \lambda$
- Largest triangle: $9.12E-2 \lambda$
- Number of triangles: 668,352
- Single node per triangle

Cube - Helmholtz

T (dir.)	Acc.	Error (pot.)	Error (grad.)	T (sec.)	Mem. (Mb)
376950	10^{-3}	0.97E-3	0.74E-3	393	364
376950	10^{-6}	0.73E-6	0.26E-7	1022	1295
376950	10^{-9}	0.23E-9	0.17E-10	2077	1001

Cube - Laplace

T (dir.)	Acc.	Error (pot.)	Error (grad.)	T (sec.)	Mem. (Mb)
56433	10^{-3}	0.94-3	0.60E-3	52	201
56433	10^{-6}	0.41E-6	0.34E-6	132	272
56433	10^{-9}	0.28E-9	0.17E-9	231	362

Conclusions

- A fairly mature technology
- Unlike the Laplace case, it is technical (as opposed to incantational), even on the most basic level - explain
- It is not enough to “invent” an order n (or $n \cdot \log(n)$, or whatever) scheme any more - constants matter
- Accuracy control, careful testing, etc.
- Implementation practices
- Robustness and ease of use
- Algorithms are becoming technical and involved; have to be developed by competent groups
- An engineering discipline vs. black art
- There are still some freebies left!